

三洋2SB474 はゲルマニウム合金接合型トランジスタです。電流増幅率の直線性にすぐれており低歪率の電力増幅回路に最適です。

The SANYO 2SB474 is a p-n-p alloy junction type germanium transistor, and has a linear dc current gain, designed for a low distortion power amplifier.

絶対最大定格 ABSOLUTE MAXIMUM RATINGS

Ta = 25°C

ITEM	SYMBOL	2SB474	UNIT
コレクタ・ベース間電圧 Collector to Base Voltage	V _{CB0}	-35	volts
コレクタ・エミッタ間電圧 Collector to Emitter Voltage	V _{CER}	*35	volts
エミッタ・ベース間電圧 Emitter to Base Voltage	V _{EB0}	-6	volts
コレクタ電流 Collector Current	I _c	-2	A
コレクタ損失 Collector Power Dissipation	P _c	*12	W
接合部温度 Junction Temperature	T _j	85	°C
保存温度 Storage Temperature	T _{stg}	-55 ~ +85	°C

*R_{θE} = 100 Ω, *T_c = 25°C

電気的特性 ELECTRICAL CHARACTERISTICS

Ta = 25°C

ITEM	SYMBOL	TEST CONDITION	min.	typ.	max.	UNIT
コレクタ遮断電流 Collector Cutoff Current	I _{cBO}	V _{CB} = -25V, I _E = 0			-200	μA
エミッタ遮断電流 Emitter Cutoff Current	I _{eBO}	V _{EB} = -6V, I _c = 0			-200	μA
直流電流増幅率 Forward Current Transfer Ratio	h _{FE}	V _{CE} = -1.5V, I _c = -0.2A	50	100	275	
α遮断周波数 α Cutoff Frequency	f _{αB}	V _{CB} = -1.5V, I _E = 0.2A		0.7		MHz
ベース拡がり抵抗 Base Spreading Resistance	r _{bb'}	V _{CB} = -1.5V, I _c = -0.2A f = 1MHz		15		Ω

外形寸法図 OUTLINE (Unit: mm)

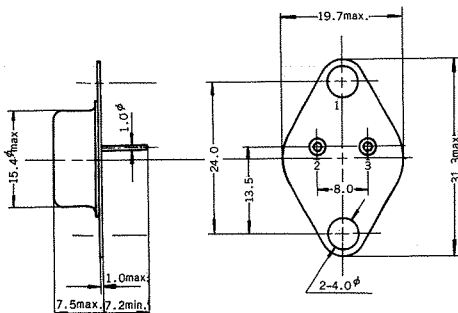

1. コレクタ Collector (ケース) (Case)
2. ベース Base
3. エミッタ Emitter

プッシュ・プル用ペア条件 Pair Condition

品名 Type	色別 Color	h _{FE} (V _{CE} = -1.5V, I _c = -0.2A)
2SB474	青 Blue	50 ~ 66
	紫 Purple	54 ~ 74
	無印 No Mark	60 ~ 83
	黒 Black	67 ~ 94
	茶 Brown	76 ~ 110
	赤 Red	90 ~ 140
	橙 Orange	110 ~ 165
	黄 Yellow	135 ~ 220
緑 Green	180 ~ 275	

特性 CHARACTERISTICS

静特性

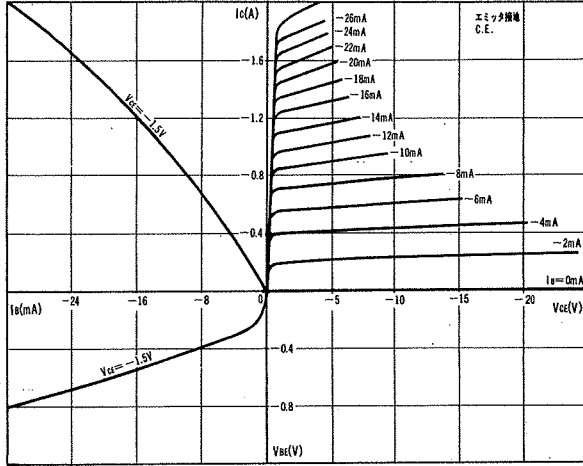

VCE 対 I_c 特性

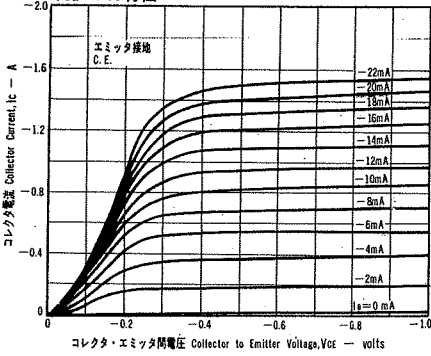

V_{BE} 対 I_c 特性

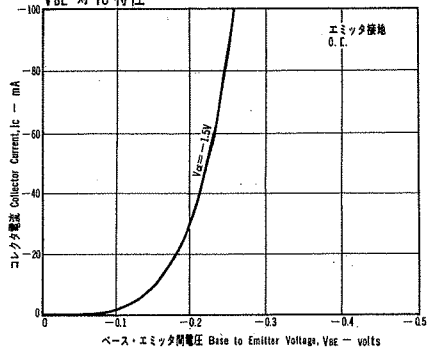

P_c 対 T_c 特性

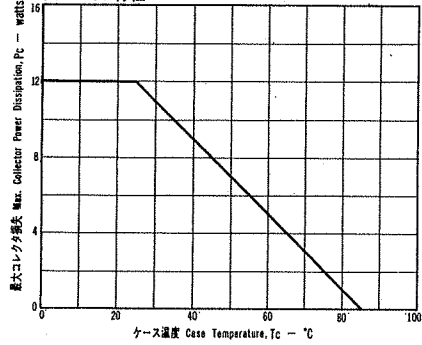

θ_{t} 対 S 特性

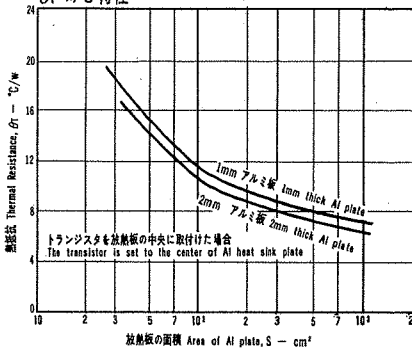

V_{CEr} 対 R_{BE} 特性

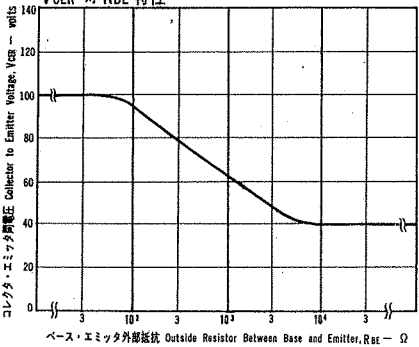

h_{FE} 対 I_c 特性

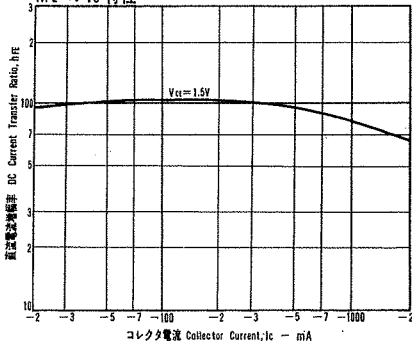

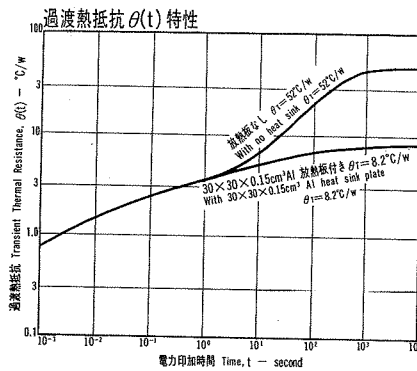
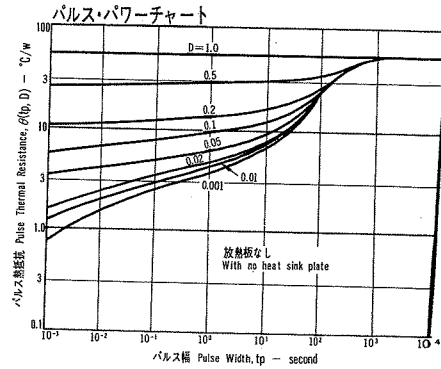
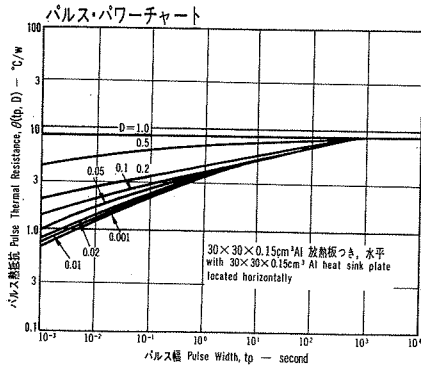

応用例 APPLICATIONS

1. 2SB474 B級プッシュ・プル回路 CLASS B PUSH-PULL CIRCUIT

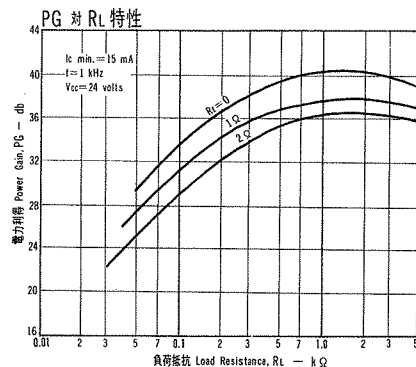
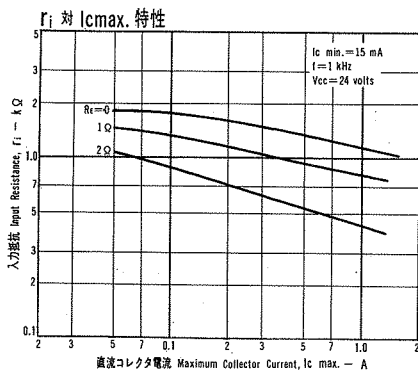
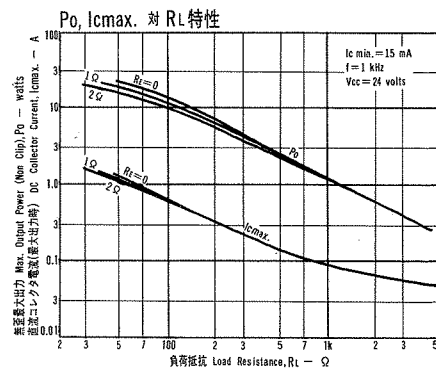
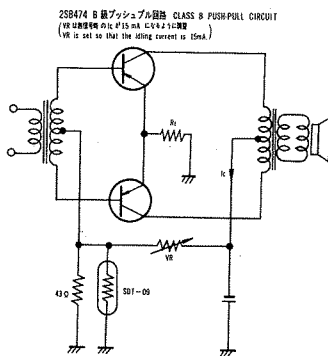

2. 2SB474 OTL 回路 CIRCUIT

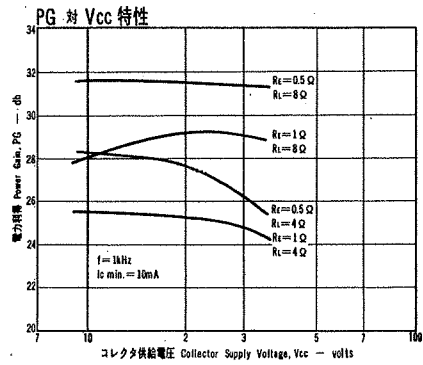
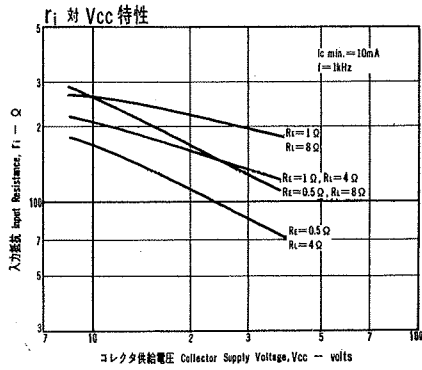
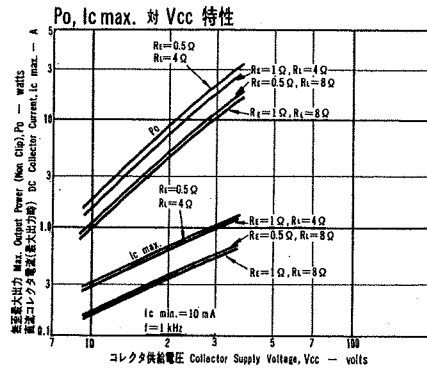
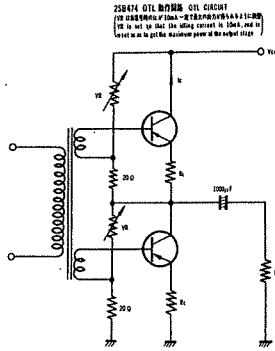

SANYO

TOKYO SANYO ELECTRIC CO., LTD.

東京営業所 電話 03-815-1111(大代表), 03-815-0247(営業)
 大阪営業所 電話 0720-72-2121(大代表), 0720-72-7861(営業)
 名古屋営業所 電話 0275-6-2111(大代表)
 福岡営業所 電話 092-6-2111(大代表)
 札幌営業所 電話 011-2-2111(大代表)

SALES OFFICE
 TOKYO, JAPAN
 Semiconductor Division, Tokyo Sanyo Electric Co., Ltd.
 Yushima Bldg. 3-10-15 Hongo Bunkyo-ku Tokyo, Japan 113
 TEL: TOKYO 03-815-1111
 CHICAGO, ILLINOIS, USA
 Nichimen Company, Inc.
 8, North Michigan Avenue, Chicago, Illinois 60602
 TEL: FJ 0-9339